

deTec4 Core Ex, C4000 Select Ex, C4000 Advanced Ex

SAFETY IN EXPLOSIVE ENVIRONMENTS

Safety light curtains

SICK
Sensor Intelligence.

A TRUSTED SOLUTION TO ELIMINATE EXPLOSION RISK

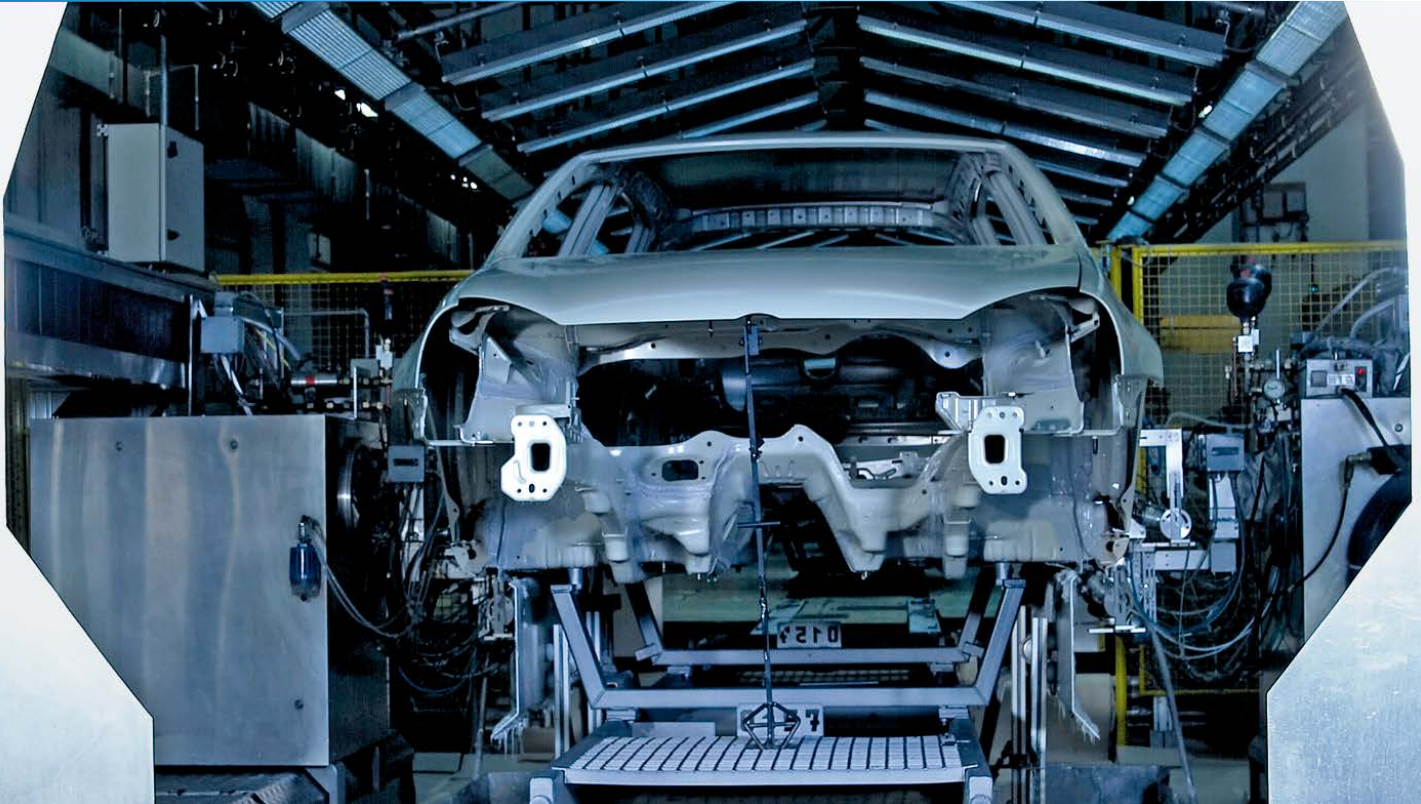

Explosive environments are governed by particularly stringent safety regulations and standards. As a global leader in the supply of opto-electronic protective devices, SICK develops innovative solutions, such as the explosion-proof enclosure for safety light curtains, to ensure these standards are adhered to.

Previously the use of safety light curtains in explosive environments was restricted as the presence of unprotected curtains in this setting could trigger an explosion. SICK's explosion-proof enclosure with an integrated safety light curtain provides a safe

solution while completely mitigating the risk of explosion. The most striking feature of this combination: optimal protection for both man and machine, even in explosive environments.

Certification with the highest protection classes



The only UL listed pre-assembled solution on the market

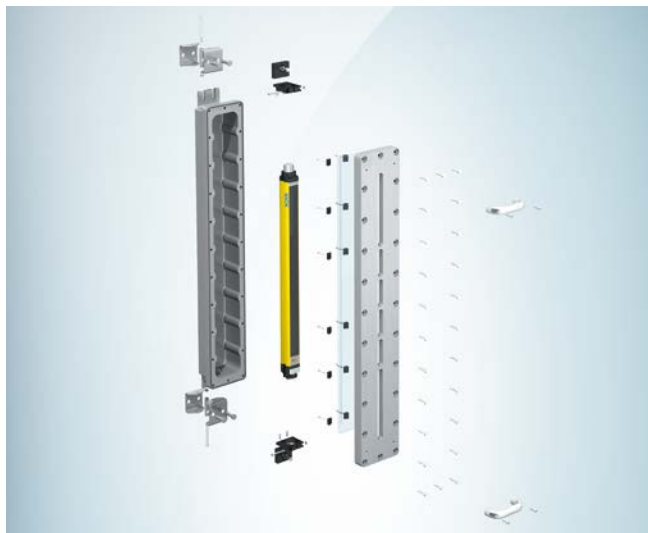

With the deTec4 Core, C4000 Select, and C4000 Advanced, you have the choice of three different safety light curtains with different protective field heights to safeguard a variety of applications.

All variants are delivered pre-installed in their protective enclosure, and also feature resistance levels in line with the requirements set out in the applicable protection classes, creating an outstanding solution like no other on the market. SICK's explosion-proof enclosure with safety light curtains is certified for use in Europe, North America and Brazil.

Classification of explosion-proof safety light curtains

In accordance with ATEX Directive 94/9/EC

Flammable substances	Protection principle	Flammable protection	Equipment group	Equipment category	Marking	Explosive group	Temperature class	Equipment protection level (EPL)	Probability of a flammable substance occurring under normal operating conditions
Gases, Mists, Vapors	Outward penetration of an explosion is ruled out	Pressure-resistant casing	II	2 G	Ex d	IIB	T6	Gb	Likely to exist ► ZONE 1
									Unlikely to exist or occurs only infrequently or temporarily ► ZONE 2
Dusts, Air mixtures	Dust explosion protection	Protection provided by housing	II	2 D	Ex tb	IIIC ¹⁾	T56 °C	Db	Likely to exist ► ZONE 21
									Unlikely to exist or occurs only infrequently or temporarily as a result of airborne dust particles ► ZONE 22

¹⁾ Conductive dust.

In accordance with NFPA 70/NEC 500

Flammable substances	Classification of explosion proof areas in accordance with NEC 500		Explosive group	Probability of a flammable substance occurring under normal operating conditions
Gases, Vapors, Liquids	Class I	Div. 1 ¹⁾	Ethylene ► group C Propane ► group D	Is most likely or likely to exist under normal operating conditions
Dust	Class II	Div. 1 ¹⁾	Metallic dust ► group E Coal dust ► group F Grain dust ► group G	
Fibers, Flyings	Class III	Div. 1 ¹⁾	–	

¹⁾ Also certified for Division 2 explosive environments.

SAFETY, EVEN IN EXTREME CONDITIONS

Safety light curtains make a crucial contribution to the effective protection of people and working environments. When combined with SICK's explosion-proof enclosure, the field of application of these devices can be expanded to include industries which require explosion protection measures and compliance with applicable standards.



Coal-fired power plants

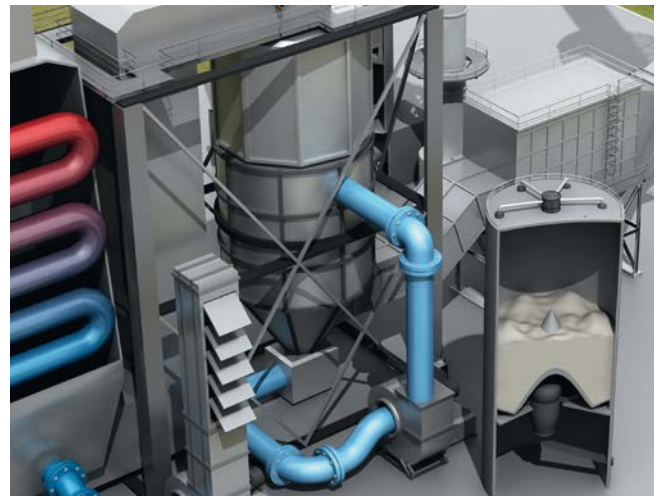

Gas industry



Fuel-fired power plants

Other typical industries

- Automotive (paint booths, dusty environments)
- Ports (containers, ships, oil rigs)
- Dusty environments in the food industry
- Pharmaceuticals manufacturers
- Sewage plants
- Incineration plants (recycling)
- Wood industry
- Agricultural industry
- Distilleries

POSSIBLE APPLICATIONS

Automotive – paint booth

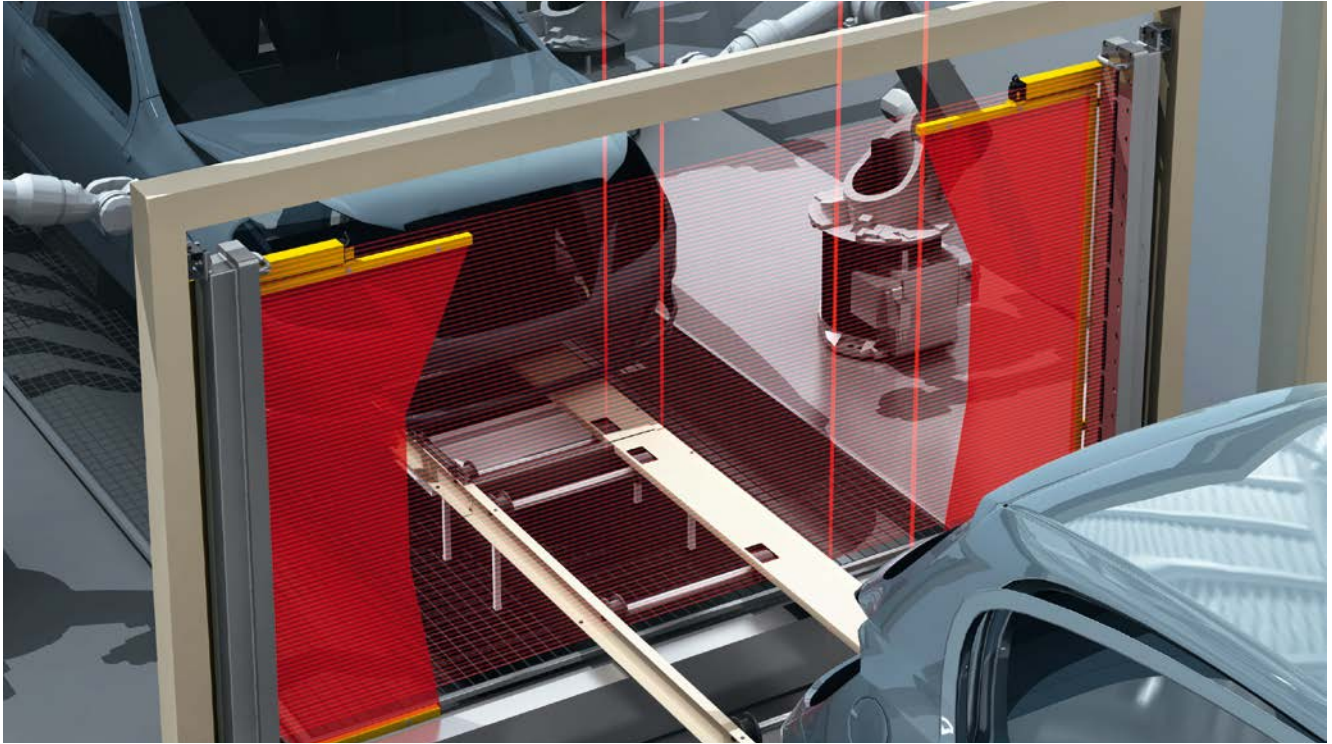

Highly explosive vapors arise during the painting of automobile bodies.

Food and beverage – flour filling plants

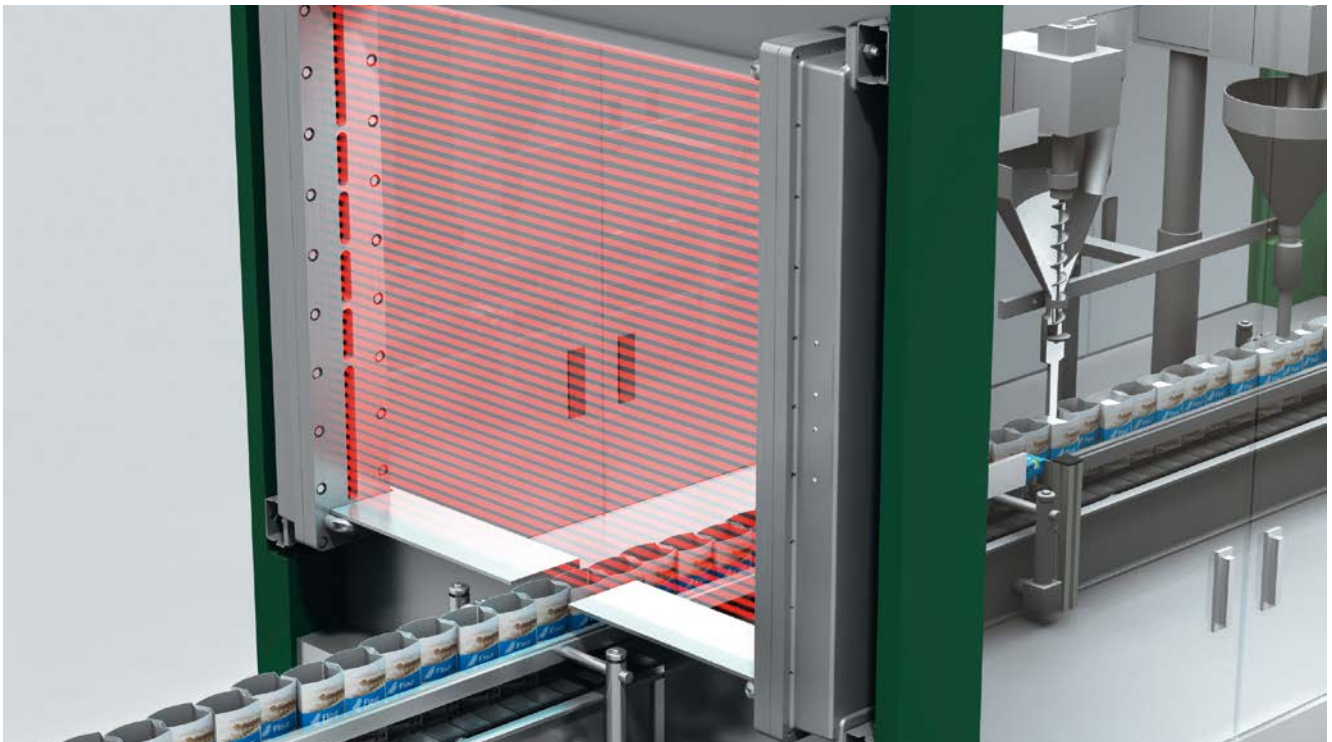

Flour dust in the vicinity of a filling station with a screw feeder carries a constant risk of explosion.

ONE CONCEPT: TEN VARIANTS

The rugged aluminum explosion-proof enclosure is available in three different lengths. This enables protective field heights of 600 mm, 900 mm, 1,200 mm and even 1,500 mm (only with deTec4 Core). A uniform resolution of 30 mm means a scanning range of 8 m to 16 m can be achieved (depending on the model).

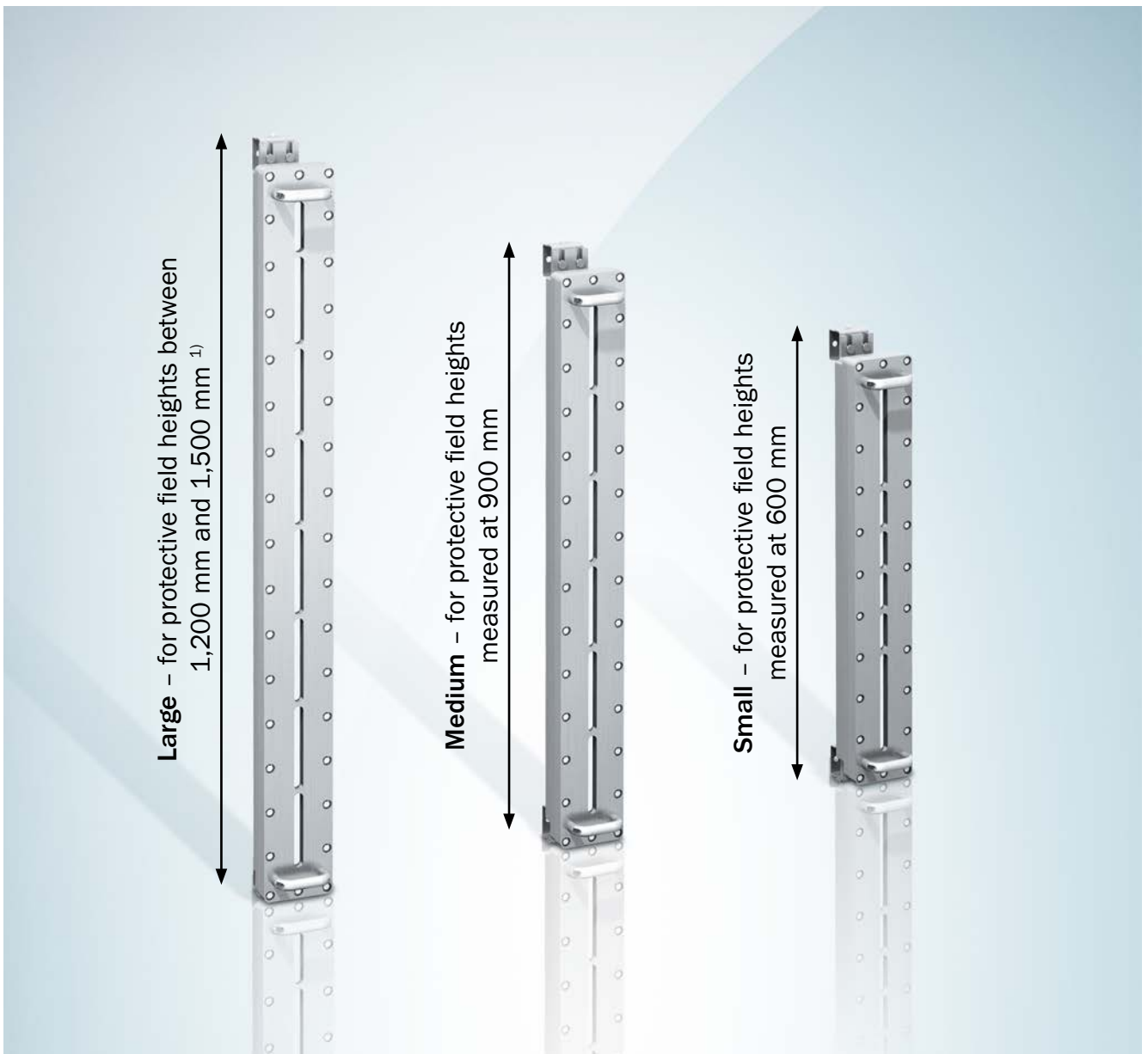

¹⁾ 1,500 mm only with deTec4 Core.

A GLIMPSE INSIDE

The deTec4 Core, C4000 Select and C4000 Advanced safety light curtain models offer a range of protective field heights and can be combined to create ten different variants within just a single housing concept, opening up a whole range of application possibilities.

deTec4 Core, C4000 Select and C4000 Advanced: for safety you can trust



Product	Protective field height				Resolution	Scanning range (max.)	
	600 mm	900 mm	1,200 mm	1,500 mm		8 m	16 m
Explosion-proof enclosure (small)							
deTec4 Core	■				■	■	
C4000 Select	■				■		■
C4000 Advanced	■				■		■
Explosion-proof enclosure (medium)							
deTec4 Core		■			■	■	
C4000 Select		■			■		■
C4000 Advanced		■			■		■
Explosion-proof enclosure (large)							
deTec4 Core			■	■	■	■	
C4000 Select			■		■		■
C4000 Advanced			■		■		■

A CLEAR ADVANTAGE

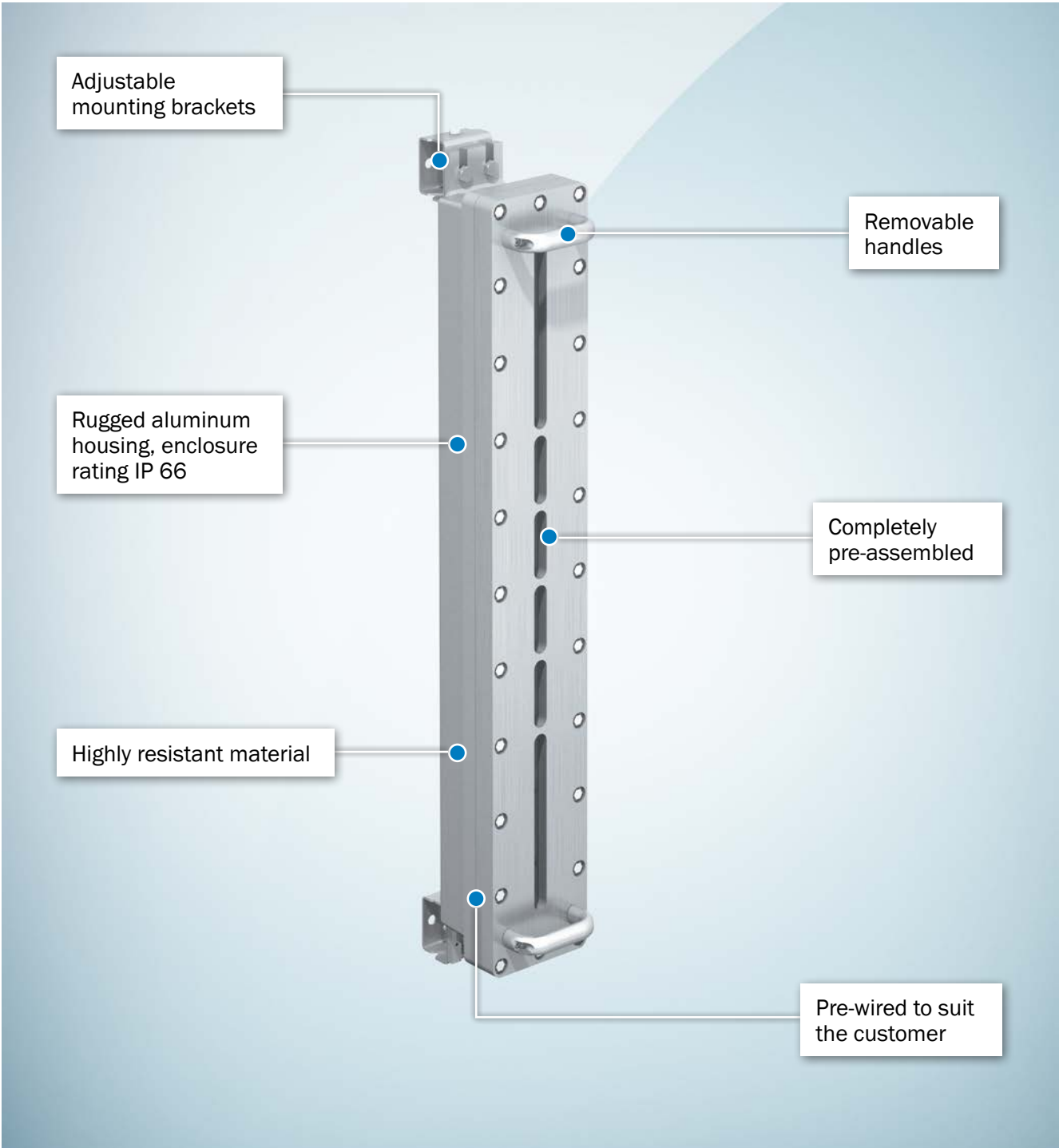

+ Simple mounting and optimal alignment

Adjustable mounting brackets

The well-thought-out mounting system with adjustable brackets enables secure attachment and provides the required flexibility for optimal alignment of the housing.

+ Simple to transport and easy to replace

Removable handle

The removable handle facilitates transport, mounting, and alignment of the protective housing. Furthermore, the front panel can be easily removed. Devices can thus be replaced without having to remove the entire explosion-proof enclosure.

+ Minimum downtime

Rugged aluminum housing, enclosure rating IP 66

Durable, easy-to-clean material, as well as protection against dust and water, ensure almost zero downtime – even in the harshest conditions.



+ Time and cost savings

Completely pre-assembled

These safety light curtains are delivered complete with explosion-proof enclosure, are quick to install and can be up and running in no time.

+ Complies with all applicable safety regulations and standards

High material resistance

All certifications confirm the high material resistance in respect to explosion-proof enclosures.



+ Quickly operational and unique to the market

Pre-wired to suit the customer

The UL Listed pre-wired solution, currently unique on the market, provides a high level of protection and fast commissioning.



Pre-wiring for Europe



Pre-wiring for North America

EFFICIENCY THAT LASTS. OR: FOR A SURE START ON THE PATH TO SUCCESS.

SICK's system solutions allow you to work more efficiently, both today and in years to come. Safety devices should not restrict the productivity of your machines or your systems. That is why extensive studies involving customer surveys are the first step in the development of each new SICK product.

This requires not only consideration of current technological enhancements: Your experiences and wishes also play a key role for our catalog of requirements. Trend-setting products such as safety laser scanners and the Flexi Soft modular safety controller were created using this process.

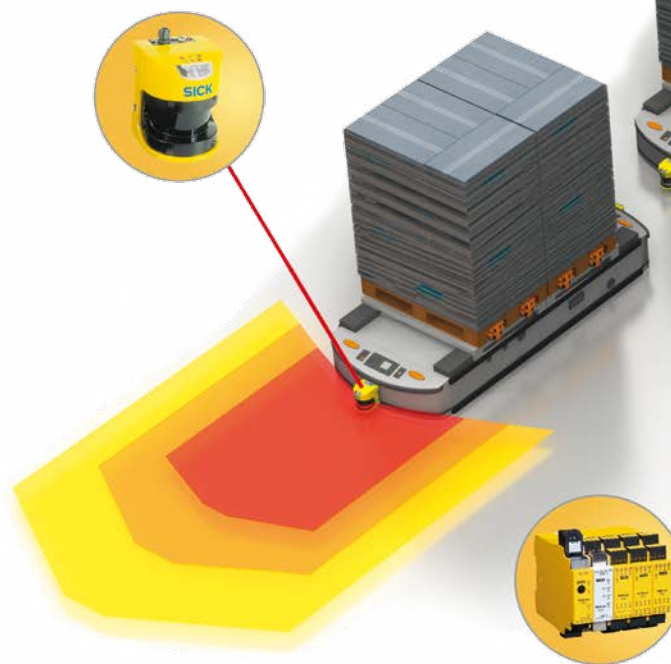

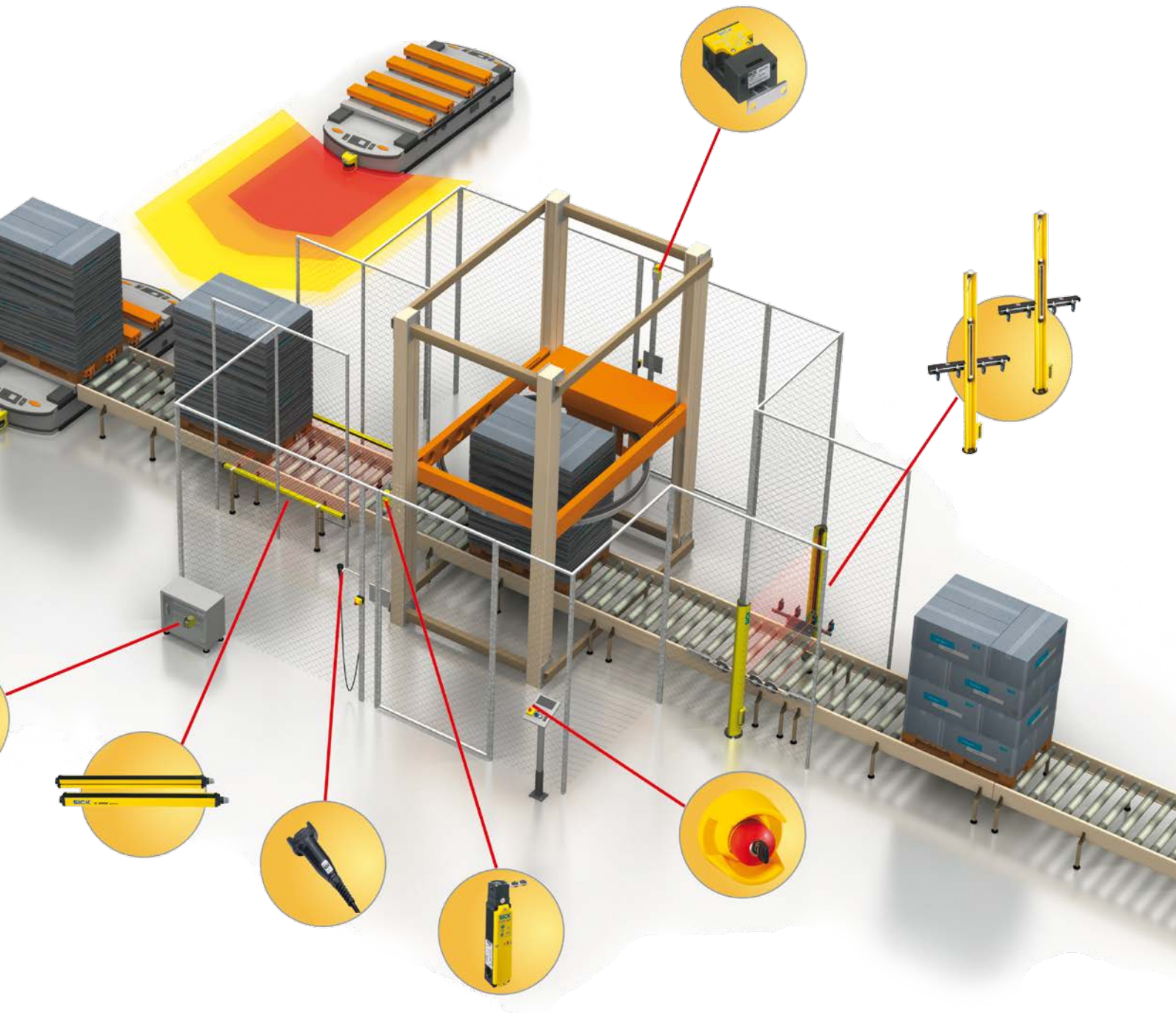

For that extra helping hand – safetyPLUS®:

safetyPLUS® from SICK offers comprehensive solutions for industrial automation – including development and services:

- Application-oriented functions and trend-setting products that increase your system efficiency
- Incorporating the currently applicable international standards in order to support your business all over the world
- Services that range from the implementation of your vision to regular maintenance
- Tools for safety engineering
- A full range of services for your machines and systems

SAFETY IN EXPLOSIVE ENVIRONMENTS











Additional information

Detailed technical data 13

Ordering information 15

Dimensional drawings16

Connection diagrams 18

Accessories 19

Product description

The explosion-proof enclosure for safety light curtains is designed and approved for use in hazardous locations according ATEX for gas: II 2 G Ex d IIB T6 Gb, for dust: II 2 D Ex tb IIIC T56°C Db. NFPA 70/NEC 500, Class I, Div. 1, groups C and D, Class II, Div. 1, groups E, F and G and Class III, Div. 1. The enclosure is compatible with a variety of SICK safety

light curtains to fit multiple applications including paint booths, granaries, chemical processing and many others. The explosion-proof enclosure and safety light curtains have been tested together and are UL listed to give you the peace of mind that your safety solution meets the necessary safety and regulatory standards.

At a glance

- ATEX for gas: II 2 G Ex d IIB T6 Gb
- ATEX for dust: II 2 D Ex tb IIIC T56°C Db
- NFPA 70/NEC 500 Class I, Div. 1, Groups C and D
- NFPA 70/NEC 500 Class II, Div. 1, Groups E, F and G
- NFPA 70/NEC 500 Class III, Div. 1
- Available in protective field heights of 600 mm, 900 mm, 1,200 mm and 1,500 mm
- Resolution of 30 mm
- Scanning range of 8 m

Your benefits

- Compatibility with multiple SICK safety light curtains offers maximum flexibility in your application
- Durable design with flexible adjustment and handling of the whole device provides easy installation and alignment
- Pre-mounted and pre-wired safety light curtains in the enclosure reduces installation time and cost
- The IP 66 enclosure rating protects the safety light curtain from water and dust to reduce downtime
- Highly visible LED status indicators provide quick troubleshooting
- One source for worldwide delivery and support of complete safety solutions

→ www.mysick.com/en/deTec4_Core_Ex

For more information, just enter the link or scan the QR code and get direct access to technical data, CAD design models, operating instructions, software, application examples and much more.



Detailed technical data

You can find more detailed data in the operating instructions. Download at → www.mysick.com

Features

Resolution	30 mm
Protective field height	600 mm ... 1,500 mm (depending on type)
Scanning range	0 m ... 8 m
Response time	10 ms ... 13 ms (depending on type)
Synchronization	Optical synchronisation

Safety-related parameters

Type	Type 4 (EN 61496)
Safety integrity level	SIL3 (IEC 61508) SILCL3 (EN 62061)
Category	Category 4 (EN ISO 13849)
Performance level	PL e (EN ISO 13849)
PFHd (mean probability of a dangerous failure per hour)	$3,7 \times 10^{-9}$ (EN ISO 13849)
T_M (mission time)	20 years (EN ISO 13849)
Safe state in the event of a fault	At least one OSSD is in the OFF state.

Interfaces

System connection	
Connection type	Male connector M12, 5-pin
Cable length	30 m
Permitted cable length	≤ 50 m
Status display	LEDs
Fieldbus, industrial network	
Integration via Flexi Soft safety controller	CANopen, DeviceNet, EtherCAT, EtherNet/IP, Modbus TCP, PROFIBUS DP, PROFINET ¹⁾

¹⁾ For further information on Flexi Soft, please see sens:Control – safe control solutions product catalog or www.sick.com/FlexiSoft.

Electrical data

	Sender	Receiver
Protection class	III (EN 50178)	
Supply voltage V_S	24 V DC (19.2 V DC ... 28.8 V DC)	
Ripple	≤ 10 % ¹⁾	
Power consumption typical	0.91 W (DC) ... 1.2 W (DC) (depending on type)	1.82 W (DC) ... 2.4 W (DC) (depending on type)
Safety outputs (OSSD)		
Type of output	–	2 PNP semiconductors, short-circuit protected, cross-circuit monitored ²⁾
Switching voltage HIGH	–	24 V DC (V _S – 2.25 V DC ... V _S)
Switching voltage LOW	–	≤ 2 V DC
Switching current	–	≤ 300 mA

¹⁾ Within the limits of V_S.

²⁾ Applies to the voltage range between –30 V and +30 V.

Mechanical data

	Sender	Receiver
Housing cross-section	161.8 mm x 142.1 mm	
Weight		
Protective field height 600 mm	28.308 kg (± 50 g)	28.318 kg (± 50 g)
Protective field height 900 mm	36.041 kg (± 50 g)	36.051 kg (± 50 g)
Protective field height 1,200 mm	43.745 kg (± 50 g)	43.755 kg (± 50 g)
Protective field height 1,500 mm	44.015 kg (± 50 g)	44.025 kg (± 50 g)

Ambient data

Enclosure rating	IP 66 (EN 60529)
Ambient operating temperature	-20 °C ... +55 °C
Storage temperature	-30 °C ... +70 °C
Air humidity	15 % ... 95 %, non-condensing
Vibration resistance	5 g, 10 Hz ... 55 Hz (EN 60068-2-6)
Shock resistance	10 g, 16 ms (EN 60068-2-29)

Ordering information

Items supplied deTec4 Core Ex:

- Safety light curtain consisting of a sender and a receiver, each inside an explosion-proof enclosure
- 2 system connection cables with open conductor heads, 30 m
- 4 handles
- 4 FlexFix brackets with spacer
- Test rod with diameter corresponding to the resolution of the safety light curtain
- Operating instructions on CD-ROM and mounting instructions as hard copy
- Adhesive label with information on the daily check
- **Resolution:** 30 mm
- **Scanning range:** 0 m ... 8 m

Protective field height	Sender		Receiver		Pair	
	Model name	Part no.	Model name	Part no.	Model name	Part no.
600 mm	EXS-06D6203B020	1068407	EXE-06D6203B020	1068406	EXP-06D6203B020	1068405
900 mm	EXS-09D6403B020	1068410	EXE-09D6403B020	1068409	EXP-09D6403B020	1068408
1,200 mm	EXS-12D6603B020	1068413	EXE-12D6603B020	1068412	EXP-12D6603B020	1068411
1,500 mm	EXS-12D6803B020	1068416	EXE-12D6803B020	1068415	EXP-12D6803B020	1068414

Dimensional drawings (Dimensions in mm (inch))

deTec4 Core Ex, 600 mm

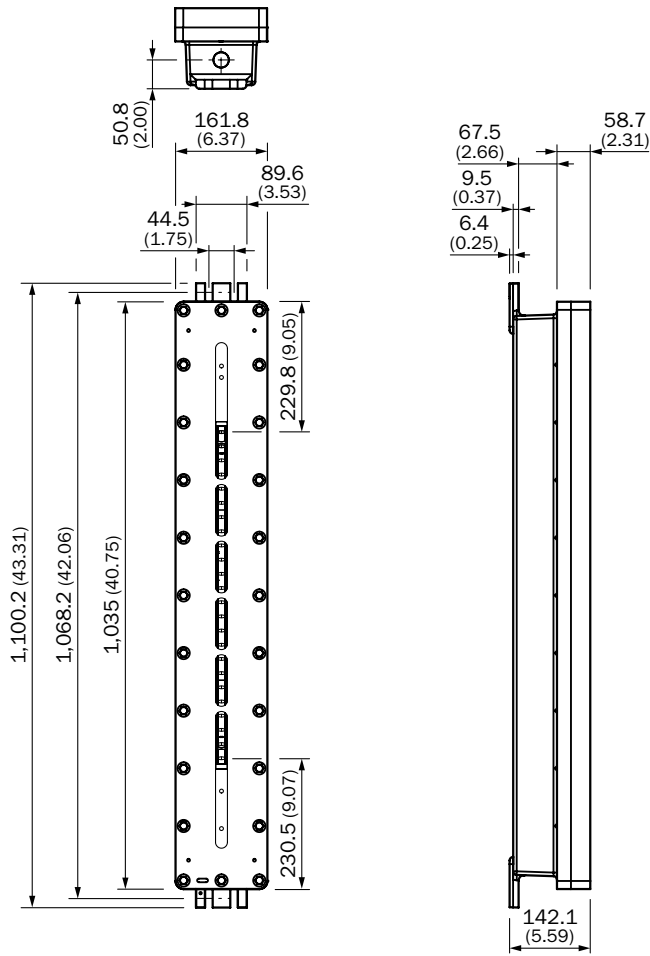

deTec4 Core Ex, 900 mm

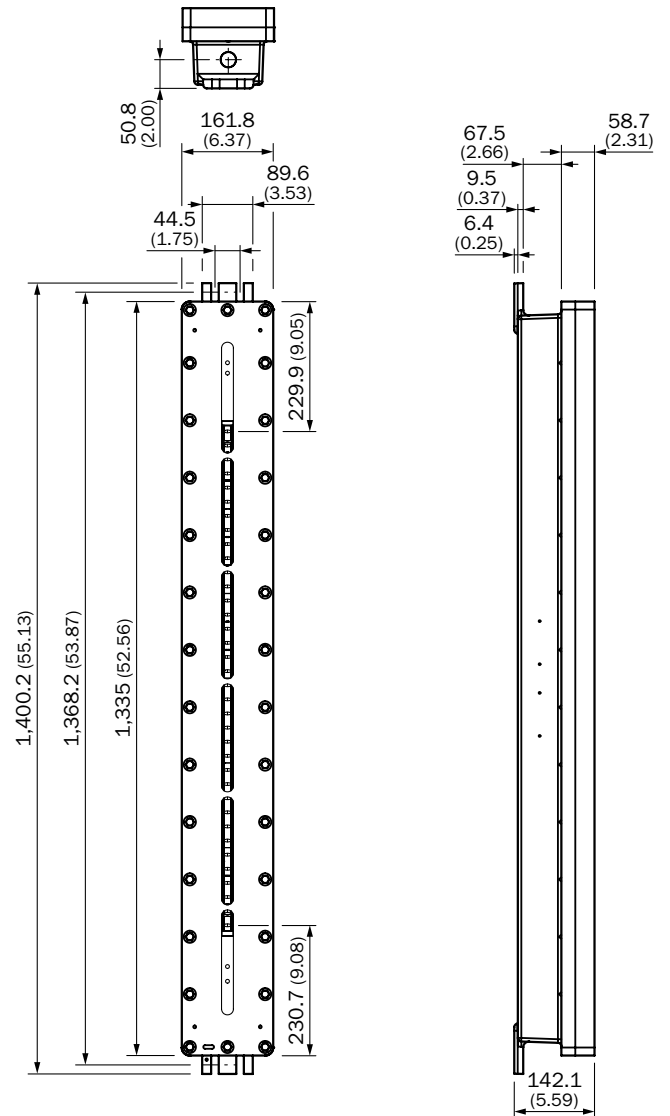

deTec4 Core Ex, 1,200 mm

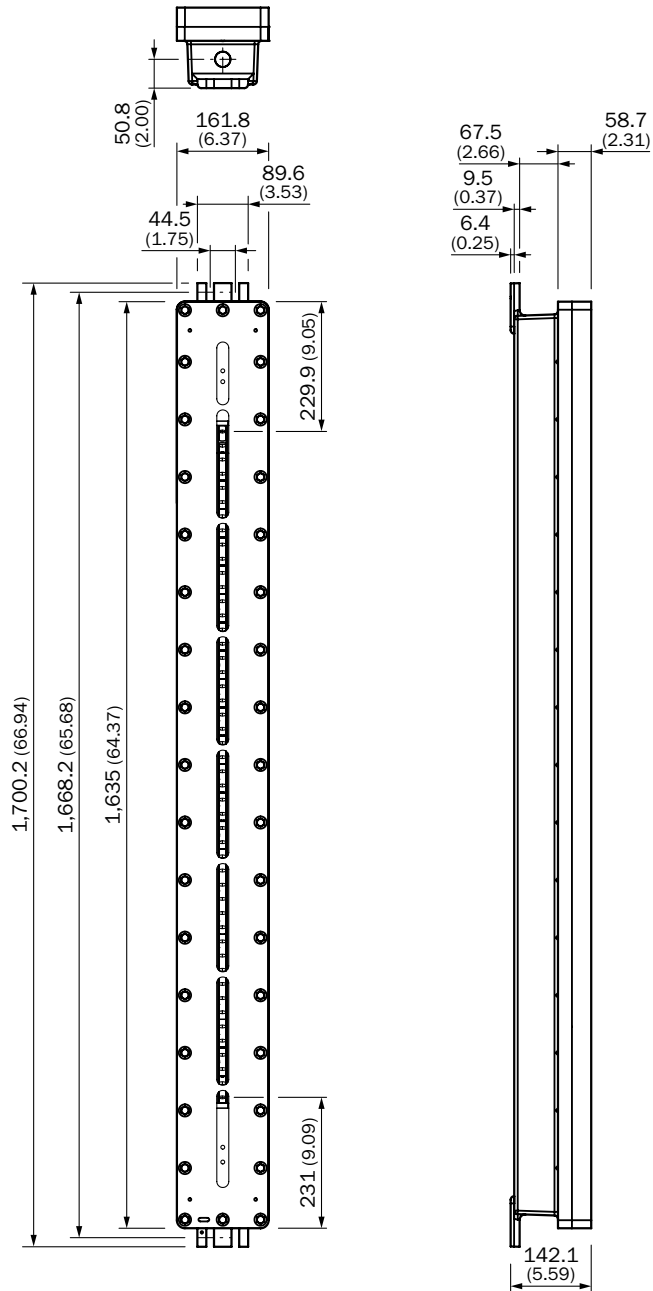

deTec4 Core Ex, 1,500 mm

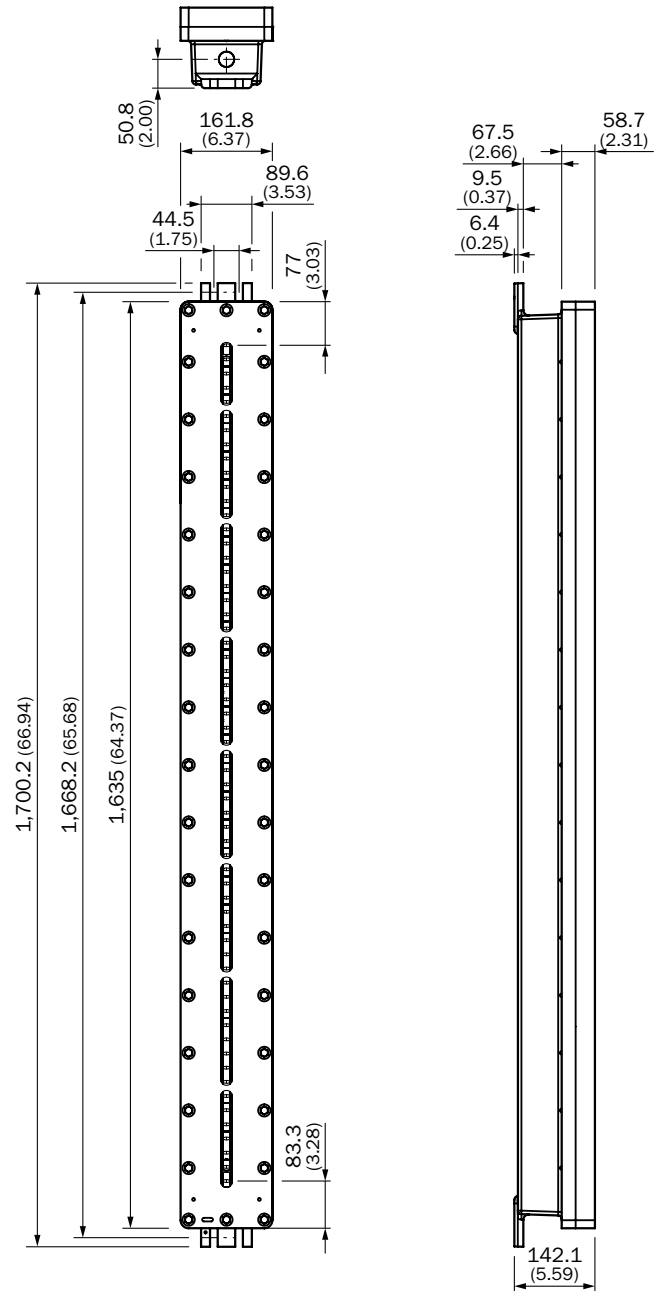

Connection diagrams

deTec safety light curtain connected to UE48-20S safety relay

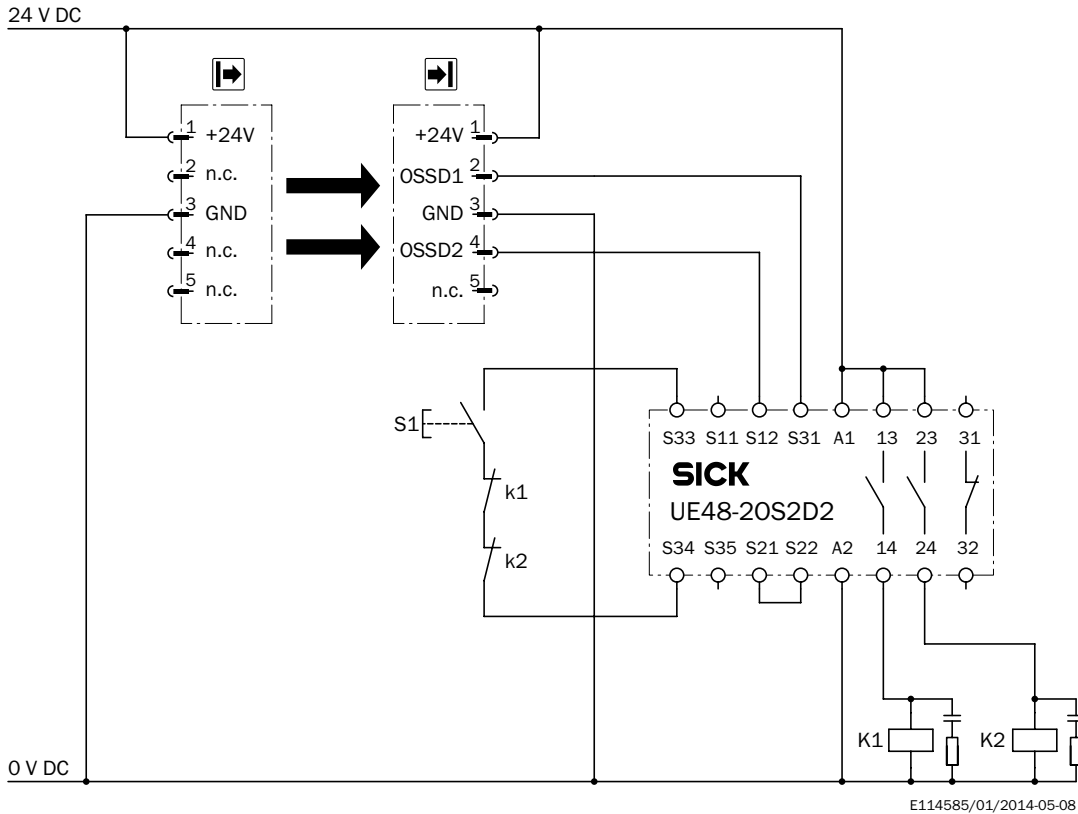

E114585/01/2014-05-08

The deTec4 Core safety light curtain can be connected to the UE48-20S switching amplifiers. It is operated with restart interlock and external device monitoring.

Functionality

When the protective field is clear, the OSSD1 and OSSD2 outputs carry voltage. The system can be switched on when K1 and K2 are in the de-energized position. Pressing the S1 button switches on the UE48 switching amplifier. Contacts 13-14 and 23-24 of the UE48 activate the K1 and K2 contac-

tors. When the protective field is interrupted, the OSSD1 and OSSD2 outputs carry no voltage. The UE48 switches off and K1, K2 are deactivated.

Fault analysis

Failure of K1 and K2 does not cause the loss of the shut-down function. Cross-circuits and shortcircuits of the OSSD1 and OSSD2 outputs are recognized and lead to the locking state. It is recognized if the K1 or K2 contactors does not de-energize.

Accessories required for commissioning

Description	Number	Items supplied	Further information
Alignment bracket for explosion-proof enclosure	2	-	→ Terminal and alignment brackets
Connecting cable	2	✓	→ Plug connectors and cables
Cable gland (depending on region)	2	-	→ Plug connectors and cables
Operating instructions	1	✓	-
Test rod	1	✓	→ Test and monitoring tools

Accessories

Mounting systems

Terminal and alignment brackets

Alignment brackets

Figure	Description	Packing unit	Model name	Part no.
	FlexFix bracket with riser	2 pieces	BEF-1SHABR002	2074627
	Alignment bracket for explosion-proof enclosure	2 pieces	BEF-1SHABRST2	2072525

Device protection (mechanical)

Protective housings and protective pipes



Figure	Description	Packing unit	Model name	Part no.
	Explosion-proof enclosure for safety light curtains with protective field height of 600 mm	1 piece	EXA-06A0000A000	1068382
	Explosion-proof enclosure for safety light curtains with protective field height of 900 mm	1 piece	EXA-09A0000A000	1068383
	Explosion-proof enclosure for safety light curtains with protective field height of 1,200 mm	1 piece	EXA-12A0000A000	1068384

Connection systems

Plug connectors and cables

Connecting cables with female connector

- **Model:** PUR, halogen-free, unshielded

Figure	Connection type		Conductor cross-section	Cable length	Model name	Part no.
	Female connector, M12, 5-pin, angled	Cable	0.34 mm ²	2 m	DOL-1205-W02MC	6025909
				5 m	DOL-1205-W05MC	6025910
				10 m	DOL-1205-W10MC	6025911
	Female connector, M12, 5-pin, straight	Cable	0.34 mm ²	2 m	DOL-1205-G02MC	6025906
				5 m	DOL-1205-G05MC	6025907
				10 m	DOL-1205-G10MC	6025908
				20 m	DOL-1205-G20MC	6050247
				30 m	DOL-1205-G30MC	6050248

Cable gland

Description	Model name	Part no.
Cable gland for the European market	Cable gland	5329001

Adapters and distributors

T-junctions



Figure	Description	Model name	Part no.
	T-connector plugs directly into receiver, splits the single home run from control cabinet between sender and receiver	DSC-1205T000025KM0	6030664

Power supply units and power cord connectors

Figure	Input voltage	Output voltage	Output current	Model name	Part no.
	100 V AC ... 240 V AC	24 V DC	≤ 2.1 A	Power supply	7028789
			≤ 3.9 A	Power supply	7028790



Reflectors and optics

Alignment aids

Figure	Description	Model name	Part no.
	Laser alignment aid for various sensors, laser class 2 (IEC 60825): Never look into the beam.	AR60	1015741
	Adapter AR60 for explosion-proof enclosure	Adapter AR60, Ex	2074849

Deflector mirrors

- **Mirror material:** glass

Figure	Description	Items supplied	Suitable for protective field height	Model name	Part no.
	Horizontal deflection	Incl. mounting kit swivel mount. Pay attention to the reduction of the scanning range!	150 mm ... 600 mm	PNS125-064	1019427
			150 mm ... 900 mm	PNS125-094	1019429
			150 mm ... 1,200 mm	PNS125-124	1019431
			150 mm ... 1,500 mm	PNS125-154	1019433
	Horizontal deflection	Incl. mounting kit swivel mount. Pay attention to the reduction of the scanning range!	150 mm ... 600 mm	PNS75-064	1019416
			150 mm ... 900 mm	PNS75-094	1019418
			150 mm ... 1,200 mm	PNS75-124	1019420
			150 mm ... 1,500 mm	PNS75-154	1019422

Further accessories

Test and monitoring tools

Figure	Description	Model name	Part no.
	30 mm diameter	Test rod 30 mm	2022602
	Test rod holder	BEF-3WNAAAAL1	2052249

SAFETY IN EXPLOSIVE ENVIRONMENTS











Additional information

Detailed technical data 23

Ordering information25

Dimensional drawings 26

Accessories..... 28

Product description

The explosion-proof enclosure for safety light curtains is designed and approved for use in hazardous locations according to ATEX for gas: II 2 G Ex d IIB T6 Gb, for dust: II 2 D Ex tb IIIC T56°C Db. NFPA 70/NEC 500, Class I, Div. 1, groups C and D, Class II, Div. 1, groups E, F and G and Class III, Div. 1. The enclosure is compatible with a variety of SICK safety

light curtains to fit multiple applications including paint booths, granaries, chemical processing and many others. The explosion-proof enclosure and safety light curtains have been tested together and are UL listed to give you the peace of mind that your safety solution meets the necessary safety and regulatory standards.

At a glance

- ATEX for gas: II 2 G Ex d IIB T6 Gb
- ATEX for dust: II 2 D Ex tb IIIC T56°C Db
- NFPA 70/NEC 500 Class I, Div. 1, Groups C and D
- NFPA 70/NEC 500 Class II, Div. 1, Groups E, F and G
- NFPA 70/NEC 500 Class III, Div. 1
- Available in protective field heights of 600 mm, 900 mm and 1,200 mm
- Resolution of 30 mm
- Scanning range of 16 m

Your benefits

- Compatibility with multiple SICK safety light curtains offers maximum flexibility in your application
- Durable design with flexible adjustment and handling of the whole device provides easy installation and alignment
- Pre-mounted and pre-wired safety light curtains in the enclosure reduces installation time and cost
- The IP 66 enclosure rating protects the safety light curtain from water and dust to reduce downtime
- Highly visible LED status indicators provide quick troubleshooting
- One source for worldwide delivery and support of complete safety solutions

→ www.mysick.com/en/C4000_Select_Ex

For more information, just enter the link or scan the QR code and get direct access to technical data, CAD design models, operating instructions, software, application examples and much more.



Detailed technical data

You can find more detailed data in the operating instructions. Download at → www.mysick.com

Features

Resolution	30 mm
Protective field height	600 mm / 900 mm / 1,200 mm (depending on type)
Scanning range	0 m ... 16 m
Response time	11 ms / 12 ms / 13 ms (depending on type)
Synchronization	Optical synchronisation
Integrated LED indicator lamp on the top end cap of the receiver	✓

Safety-related parameters

Type	Type 4 (IEC 61496)
Safety integrity level	SIL3 (IEC 61508) SILCL3 (IEC 62061)
Category	Category 4 (EN ISO 13849)
Performance level	PL e (EN ISO 13849)
PFHd (mean probability of a dangerous failure per hour)	16×10^{-9} (EN ISO 13849)
T_M (mission time)	20 years (EN ISO 13849)
Safe state in the event of a fault	At least one OSSD is in the OFF state.

Functions

	Functions	Delivery status
Beam coding	✓	Non-coded
Configurable scanning range	✓	4 m ... 16 m

Interfaces

System connection	
Connection type	Male connector M12, 5-pin
Cable length	30 m
Permitted cable length	≤ 30 m ¹⁾
Configuration method	DIP switch
Display elements	7-segment display
Status display	LEDs
Fieldbus, industrial network	
Integration via Flexi Soft safety controller	CANopen, DeviceNet, EtherCAT, EtherNet/IP, Modbus TCP, PROFIBUS DP, PROFINET ²⁾

¹⁾ Depending on load, power supply and wire cross-section. The technical specifications must be observed.

²⁾ For further information on Flexi Soft, please see sens:Control – safe control solutions product catalog or www.sick.com/FlexiSoft.

Electrical data

	Sender	Receiver
Protection class	III (EN 50178)	
Supply voltage V_s	24 V DC (19.2 V DC ... 28.8 V DC) ¹⁾	
Ripple	$\leq 10\%$ ²⁾	
Power consumption	5.3 W (DC) / 5.7 W (DC) / 6.1 W (DC)	7.9 W (DC) / 8 W (DC) / 8.4 W (DC)
Safety outputs (OSSD)		
Type of output	-	2 PNP semiconductors, short-circuit protected, cross-circuit monitored ³⁾
Switching voltage HIGH	-	24 V DC ($V_s - 2.25$ V DC ... V_s)
Switching voltage LOW	-	≤ 2 V DC
Switching current	-	≤ 500 mA

¹⁾ The external voltage supply must be capable of buffering brief mains voltage failures of 20 ms as specified in EN 60 204-1. Suitable power supplies are available as accessories from SICK.

²⁾ Within the limits of U_v .

³⁾ Applies to the voltage range between -30 V and +30 V.

Mechanical data

	Sender	Receiver
Housing cross-section	161.8 mm x 142.1 mm	
Weight		
Protective field height 600 mm	29.446 kg (± 50 g)	29.449 kg (± 50 g)
Protective field height 900 mm	37.838 kg (± 50 g)	37.818 kg (± 50 g)
Protective field height 1,200 mm	46.202 kg (± 50 g)	46.159 kg (± 50 g)

Ambient data

Enclosure rating	IP 66 (EN 60529)
Ambient operating temperature	0 °C ... +55 °C
Storage temperature	-25 °C ... +70 °C
Air humidity	15 % ... 95 %, non-condensing
Vibration resistance	5 g, 10 Hz ... 55 Hz (IEC 60068-2-6)
Shock resistance	16 g, 16 ms (IEC 60068-2-29)

Other information

	Sender	Receiver
Integrated laser alignment aid		
Light source	Laser	-
Laser class	1 (IEC 60825-1), eye-safe	-
Type of light	Visible red light	-
Wave length	650 nm	-
Power consumption	≤ 0.39 W	-

Ordering information

Items supplied C4000 Select Ex:

- Safety light curtain consisting of a sender and a receiver, each inside an explosion-proof enclosure
- 2 system connection cables with open conductor heads, 30 m
- 4 handles
- 4 swivel mount brackets
- Test rod with diameter corresponding to the resolution of the safety light curtain
- Operating instructions on CD-ROM and mounting instructions as hard copy
- Adhesive label with information on the daily check
- **Resolution:** 30 mm
- **Scanning range:** 0 m ... 16 m

Protective field height	Sender		Receiver		Pair	
	Model name	Part no.	Model name	Part no.	Model name	Part no.
600 mm	EXS-06B6203B020	1068389	EXE-06B6203B020	1068388	EXP-06B6203B020	1068387
900 mm	EXS-09B6403B020	1068392	EXE-09B6403B020	1068391	EXP-09B6403B020	1068390
1,200 mm	EXS-12B6603B020	1068395	EXE-12B6603B020	1068394	EXP-12B6603B020	1068393

Dimensional drawings (Dimensions in mm (inch))

C4000 Select Ex, 600 mm

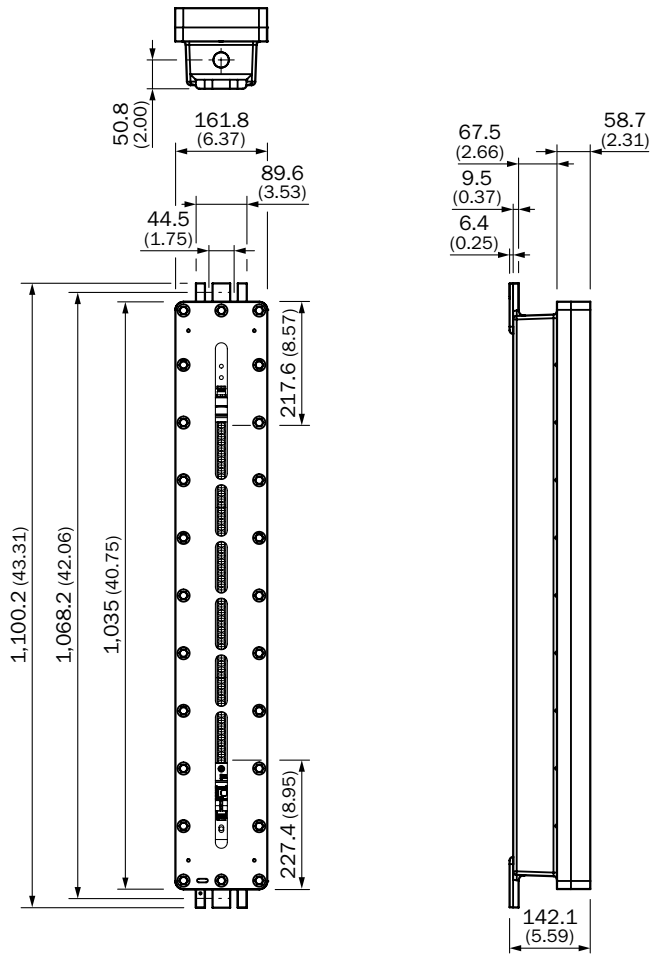

C4000 Select Ex, 900 mm

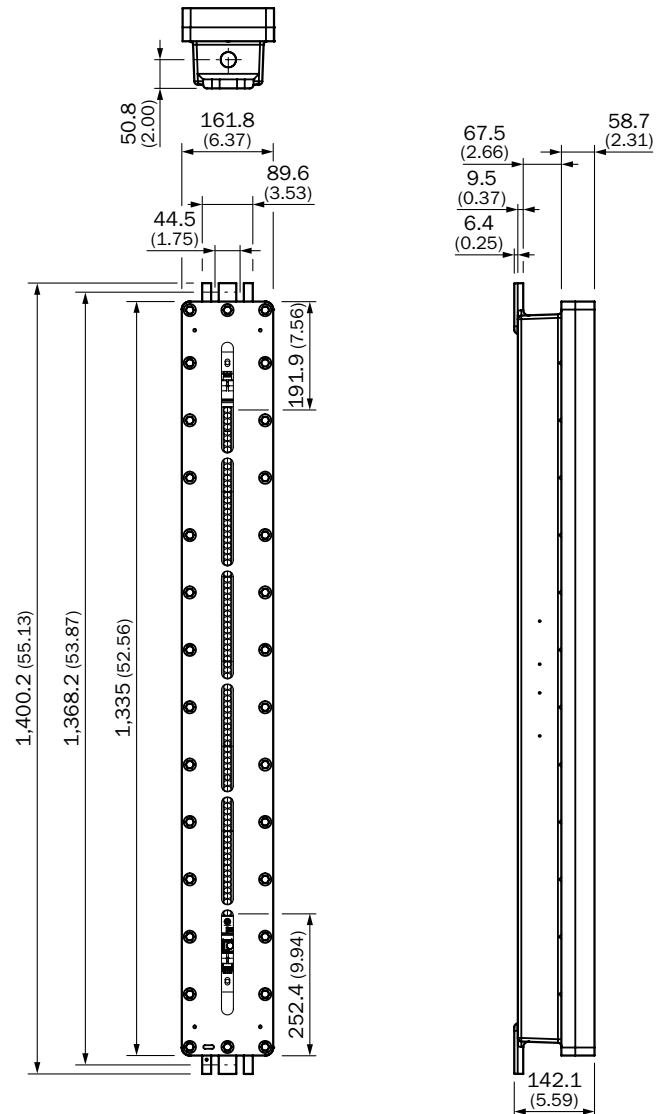

C4000 Select Ex, 1,200 mm

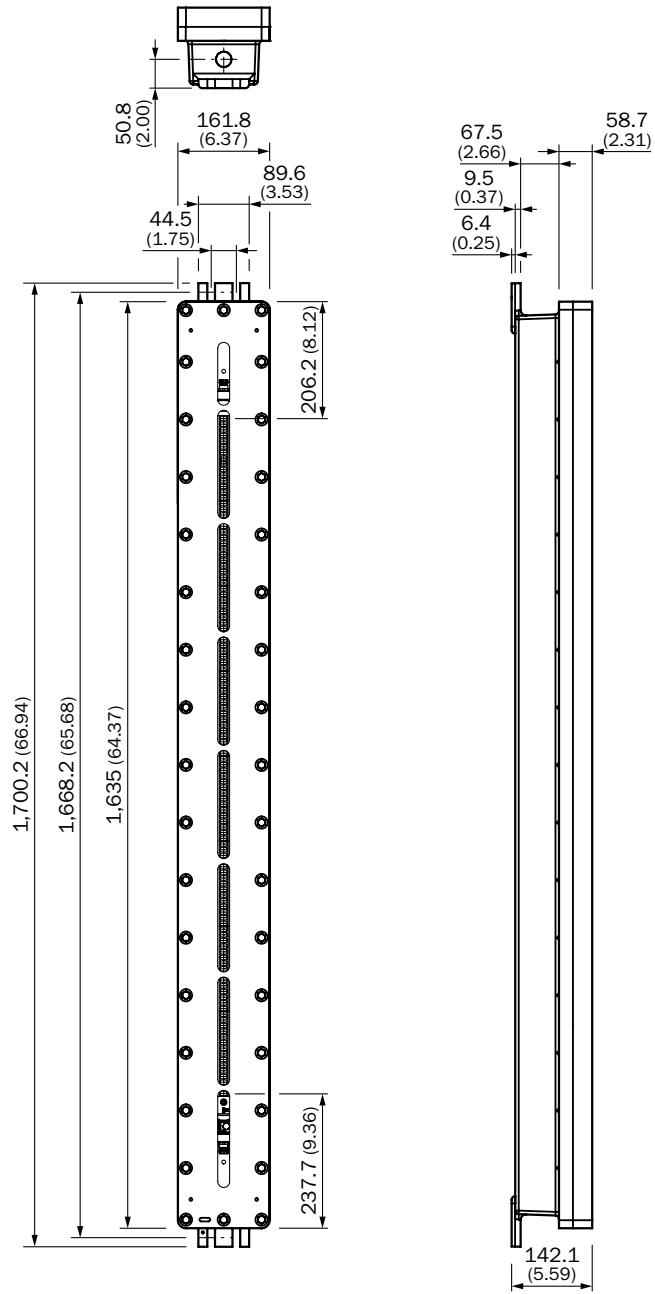

Accessories required for commissioning

Description	Number	Items supplied	Further information
Alignment bracket for explosion-proof enclosure	2	-	→ Terminal and alignment brackets
Connecting cable	2	✓	→ Plug connectors and cables
Operating instructions	1	✓	-
Test rod	1	✓	→ Test and monitoring tools

Accessories

Mounting systems

Terminal and alignment brackets

Alignment brackets

Figure	Description	Packing unit	Model name	Part no.
	Alignment bracket for explosion-proof enclosure	2 pieces	BEF-1SHABRST2	2072525
	Swivel mount bracket	2 pieces	BEF-2SMGER002	2074530

Device protection (mechanical)

Protective housings and protective pipes



Figure	Description	Packing unit	Model name	Part no.
	Explosion-proof enclosure for safety light curtains with protective field height of 600 mm	1 piece	EXA-06A0000A000	1068382
	Explosion-proof enclosure for safety light curtains with protective field height of 900 mm	1 piece	EXA-09A0000A000	1068383
	Explosion-proof enclosure for safety light curtains with protective field height of 1,200 mm	1 piece	EXA-12A0000A000	1068384

Connection systems

Plug connectors and cables

Connecting cables with female connector

- **Model:** PUR, halogen-free, unshielded

Figure	Connection type		Conductor cross-section	Cable length	Model name	Part no.
	Female connector, M12, 5-pin, angled	Cable	0.34 mm ²	2 m	DOL-1205-W02MC	6025909
				5 m	DOL-1205-W05MC	6025910
				10 m	DOL-1205-W10MC	6025911
	Female connector, M12, 5-pin, straight	Cable	0.34 mm ²	2 m	DOL-1205-G02MC	6025906
				5 m	DOL-1205-G05MC	6025907
				10 m	DOL-1205-G10MC	6025908
				20 m	DOL-1205-G20MC	6050247
				30 m	DOL-1205-G30MC	6050248

Adapters and distributors

T-junctions



Figure	Description	Model name	Part no.
	T-connector plugs directly into receiver, splits the single home run from control cabinet between sender and receiver	DSC-1205T000025KM0	6030664

Power supply units and power cord connectors

Figure	Input voltage	Output voltage	Output current	Model name	Part no.
	100 V AC ... 240 V AC	24 V DC	≤ 2.1 A	Power supply	7028789
			≤ 3.9 A	Power supply	7028790



Reflectors and optics

Alignment aids

Figure	Description	Model name	Part no.
	Laser alignment aid for various sensors, laser class 2 (IEC 60825): Never look into the beam.	AR60	1015741
	Adapter AR60 for explosion-proof enclosure	Adapter AR60, Ex	2074849

Deflector mirrors

- **Mirror material:** glass

Figure	Description	Items supplied	Suitable for protective field height	Model name	Part no.
	Horizontal deflection	Incl. mounting kit swivel mount. Pay attention to the reduction of the scanning range!	150 mm ... 600 mm	PNS125-064	1019427
			150 mm ... 900 mm	PNS125-094	1019429
			150 mm ... 1,200 mm	PNS125-124	1019431
			150 mm ... 600 mm	PNS75-064	1019416
			150 mm ... 900 mm	PNS75-094	1019418
			150 mm ... 1,200 mm	PNS75-124	1019420

Further accessories

Test and monitoring tools

Figure	Description	Model name	Part no.
	30 mm diameter	Test rod 30 mm	2022602
	Test rod holder	BEF-3WNAAAAL1	2052249

SAFETY IN EXPLOSIVE ENVIRONMENTS











Additional information

Detailed technical data 33

Ordering information 35

Dimensional drawings 36

Connection diagrams 38

Accessories 39

Product description

The explosion-proof enclosure for safety light curtains is designed and approved for use in hazardous locations according to ATEX for gas: II 2 G Ex d IIB T6 Gb, for dust: II 2 D Ex tb IIIC T56°C Db. NFPA 70/NEC 500, Class I, Div. 1, groups C and D, Class II, Div. 1, groups E, F and G and Class III, Div. 1. The enclosure is compatible with a variety of SICK safety

light curtains to fit multiple applications including paint booths, granaries, chemical processing and many others. The explosion-proof enclosure and safety light curtains have been tested together and are UL listed to give you the peace of mind that your safety solution meets the necessary safety and regulatory standards.

At a glance

- ATEX for gas: II 2 G Ex d IIB T6 Gb
- ATEX for dust: II 2 D Ex tb IIIC T56°C Db
- NFPA 70/NEC 500 Class I, Div. 1, Groups C and D
- NFPA 70/NEC 500 Class II, Div. 1, Groups E, F and G
- NFPA 70/NEC 500 Class III, Div. 1
- Available in protective field heights of 600 mm, 900 mm and 1,200 mm
- Resolution of 30 mm
- Scanning range of 16 m

Your benefits

- Compatibility with multiple SICK safety light curtains offers maximum flexibility in your application
- Durable design with flexible adjustment and handling of the whole device provides easy installation and alignment
- Pre-mounted and pre-wired safety light curtains in the enclosure reduces installation time and cost
- The IP 66 enclosure rating protects the safety light curtain from water and dust to reduce downtime
- Highly visible LED status indicators provide quick troubleshooting
- One source for worldwide delivery and support of complete safety solutions

→ www.mysick.com/en/C4000_Advanced_Ex

For more information, just enter the link or scan the QR code and get direct access to technical data, CAD design models, operating instructions, software, application examples and much more.



Detailed technical data

You can find more detailed data in the operating instructions. Download at → www.mysick.com

Features

Resolution	30 mm
Protective field height	600 mm / 900 mm / 1,200 mm (depending on type)
Scanning range	0 m ... 16 m
Response time	11 ms / 12 ms / 13 ms (depending on type)
Synchronization	Optical synchronisation

Safety-related parameters

Type	Type 4 (IEC 61496)
Safety integrity level	SIL3 (IEC 61508) SILCL3 (IEC 62061)
Category	Category 4 (EN ISO 13849)
Performance level	PL e (EN ISO 13849)
PFHd (mean probability of a dangerous failure per hour)	15×10^{-9} (EN ISO 13849)
T_M (mission time)	20 years (EN ISO 13849)
Safe state in the event of a fault	At least one OSSD is in the OFF state.

Functions

	Functions	Delivery status
Restart interlock	✓	External
External device monitoring (EDM)	✓	Deactivated
Beam coding	✓	Non-coded
Configurable scanning range	✓	0 m ... 5 m
Safe SICK device communication via EFI/SDL	✓	

Interfaces

System connection	
Connection type	Hirschmann female connector M26, 12 pin
Cable length	30 m
Permitted cable length	≤ 50 m
Configuration connection	
Connection type	M8 x 4
Configuration method	PC with CDS (Configuration and Diagnostic Software)
Display elements	7-segment display
Fieldbus, industrial network	
Integration via EFI gateways	CANopen, Ethernet TCP/IP, PROFIBUS DP, PROFIBUS PROFI-safe, PROFINET PROFI-safe ¹⁾
Integration via Flexi Soft safety controller	CANopen, DeviceNet, EtherCAT, EtherNet/IP, Modbus TCP, PROFIBUS DP, PROFINET ²⁾

¹⁾ For a suitable EFI-gateway see modules and gateways in the accessory section of connection systems.

²⁾ For further information on Flexi Soft, please see sens:Control – safe control solutions product catalog or www.sick.com/FlexiSoft.

Electrical data

	Sender	Receiver
Protection class	III (EN 50178)	
Supply voltage V_s	24 V DC (19.2 V DC ... 28.8 V DC) ¹⁾	
Ripple	$\leq 10\%$ ²⁾	
Power consumption	≤ 2 A	≤ 3 A
Safety outputs (OSSD)		
Type of output	-	2 PNP semiconductors, short-circuit protected, cross-circuit monitored ³⁾
Switching voltage HIGH	-	24 V DC ($V_s - 2.25$ V DC ... V_s)
Switching voltage LOW	-	≤ 3.5 V DC
Switching current	-	≤ 500 mA

¹⁾ The external voltage supply must be capable of buffering brief mains voltage failures of 20 ms as specified in EN 60 204-1. Suitable power supplies are available as accessories from SICK.

²⁾ Within the limits of U_v .

³⁾ Applies to the voltage range between -30 V and +30 V.

Mechanical data

	Sender	Receiver
Housing cross-section	161.8 mm x 142.1 mm	
Weight		
Protective field height 600 mm	28.512 kg (± 50 g)	28.542 kg (± 50 g)
Protective field height 900 mm	36.544 kg (± 50 g)	36.574 kg (± 50 g)
Protective field height 1,200 mm	44.549 kg (± 50 g)	44.579 kg (± 50 g)

Ambient data

Enclosure rating	IP 66 (EN 60529)
Ambient operating temperature	0 °C ... +55 °C
Storage temperature	-25 °C ... +70 °C
Air humidity	15 % ... 95 %, non-condensing
Vibration resistance	5 g, 10 Hz ... 55 Hz (IEC 60068-2-6)
Shock resistance	16 g, 16 ms (IEC 60068-2-29)

Ordering information

Items supplied C4000 Advanced Ex:

- Safety light curtain consisting of a sender and a receiver, each inside an explosion-proof enclosure
- 2 system connection cables with open conductor heads, 30 m
- Connection cable for configuration and diagnosis
- 4 handles
- 4 reinforced stainless steel brackets, swivel-mount and 2 mounting brackets, L-shaped
- Test rod with diameter corresponding to the resolution of the safety light curtain
- Operating instructions and CDS (Configuration & Diagnostic Software) on DVD and mounting instructions as hard copy
- Adhesive label with information on the daily check
- **Resolution:** 30 mm
- **Scanning range:** 0 m ... 16 m

Protective field height	Sender		Receiver		Pair	
	Model name	Part no.	Model name	Part no.	Model name	Part no.
600 mm	EXS-06C6203B020	1068398	EXE-06C6203B020	1068397	EXP-06C6203B020	1068396
900 mm	EXS-09C6403B020	1068401	EXE-09C6403B020	1068400	EXP-09C6403B020	1068399
1,200 mm	EXS-12C6603B020	1068404	EXE-12C6603B020	1068403	EXP-12C6603B020	1068402

Dimensional drawings (Dimensions in mm (inch))

C4000 Advanced Ex, 600 mm

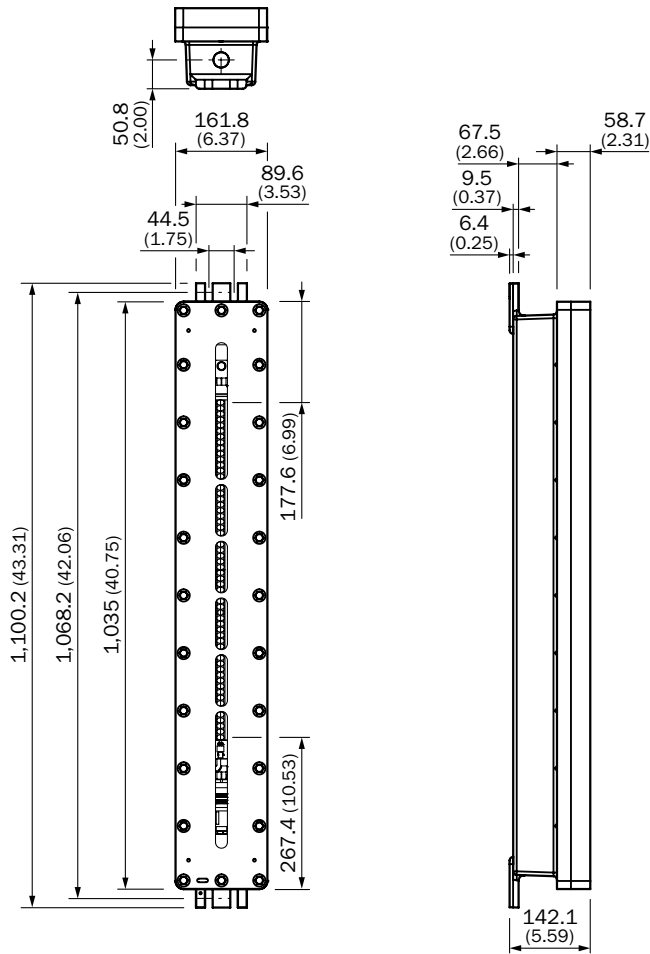

C4000 Advanced Ex, 900 mm

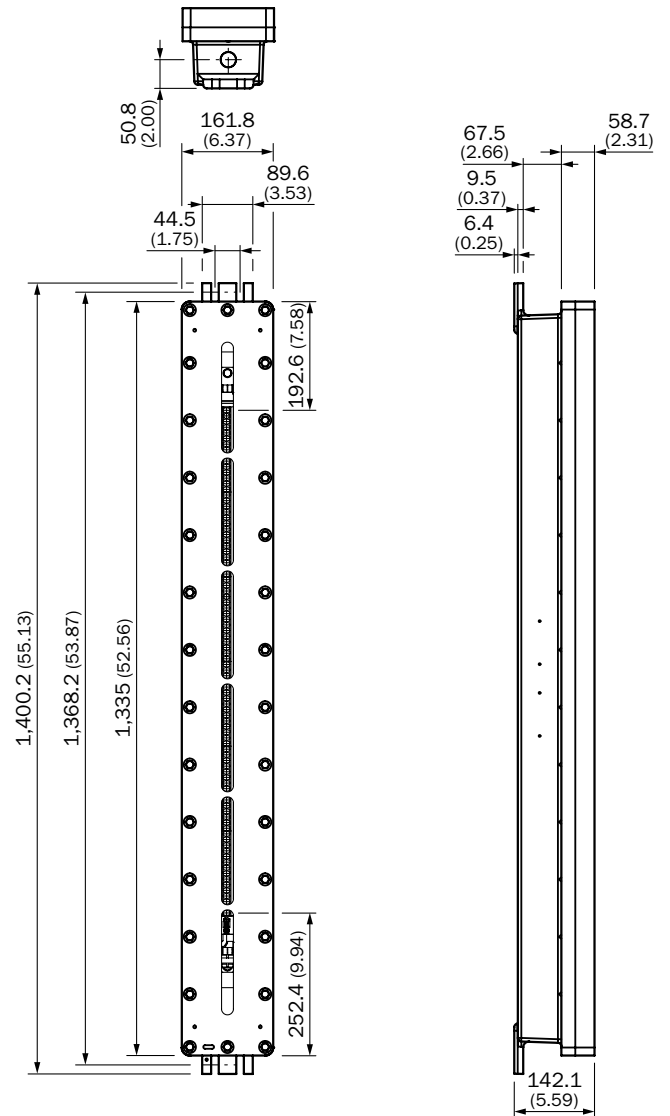

C4000 Advanced Ex, 1,200 mm

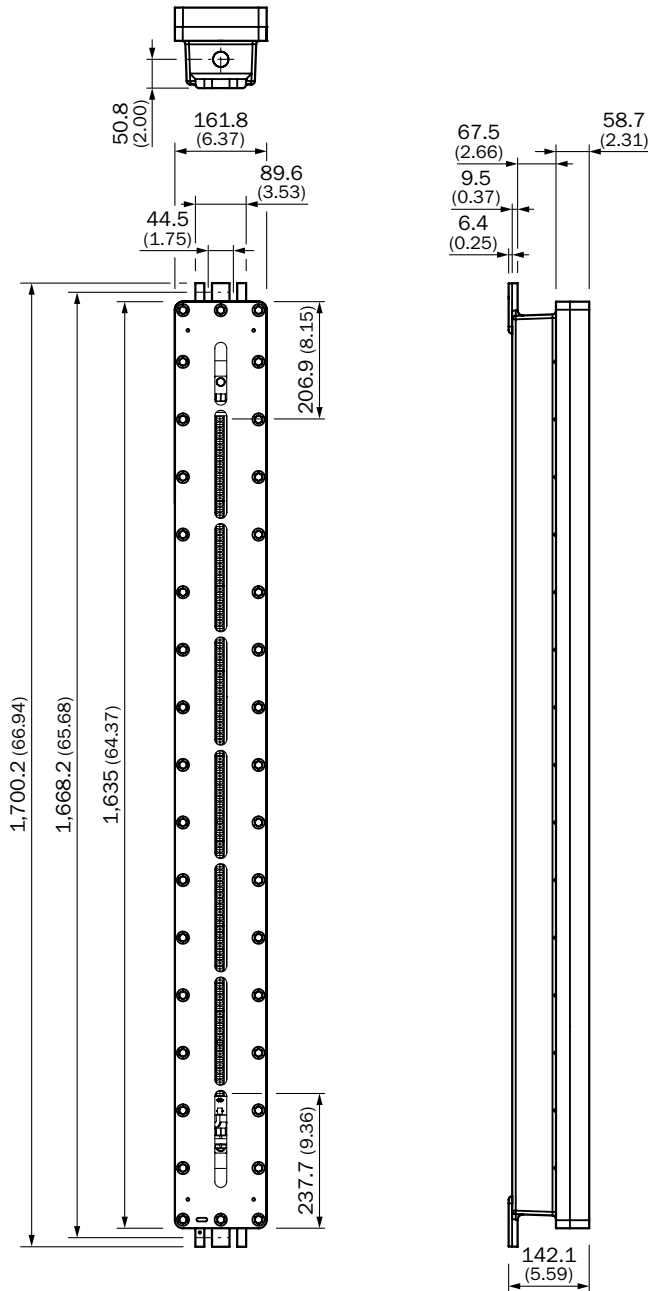

Connection diagrams

C4000 Advanced safety light curtain on UE402 safety switching amplifier

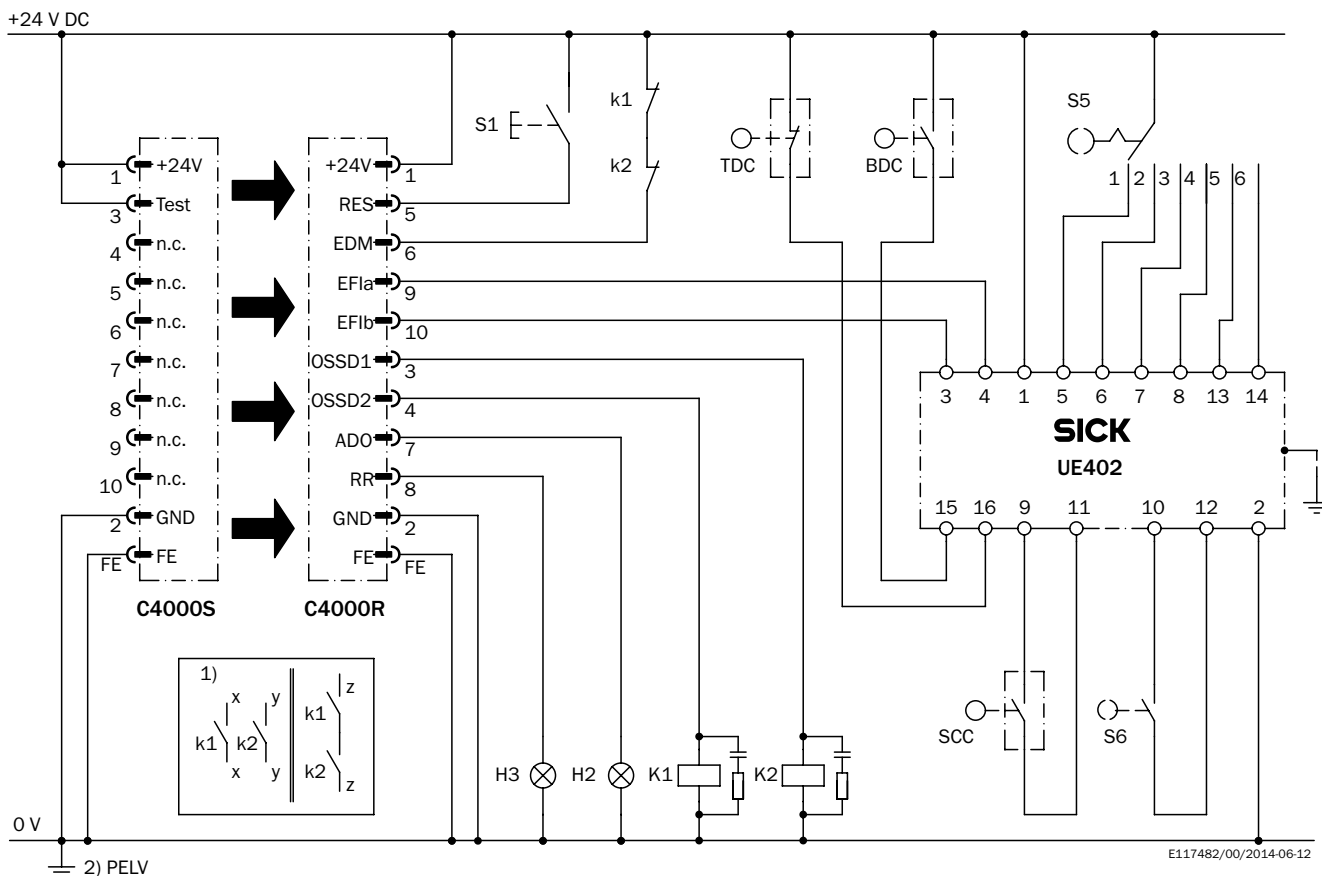

Task

Integration of a C4000 Advanced safety light curtain with UE402 in a controller. Six configurable operating modes with restart interlock and external device monitoring. PSDI mode with TDC, BDC, SCC. Teachable blanking areas.

Operating characteristics

If no object is detected in the active protective field and the K1 and K2 contactors are in the de-energized position, the H3 lamp flashes as a prompt to operate S1 control switch. The OSSDs are switched on when S1 is operated (button is pressed and released). These outputs activate K1 and K2 contactors. Upon the detection of an object in an active protective field, the OSSDs deactivate K1 and K2 contactors.

Fault analysis

The incorrect function of one of the K1 or K2 contactors does not result in the loss of the shutdown function. OSSD cross-cir-

cuits and short-circuits are detected and lead to the inhibited state (lock-out). On manipulation (e.g., jamming) of the S1 button, the system does not enable the output current circuits.

Comments

1) Output circuits. These contacts are to be connected to the controller such that, with the output circuit open, the dangerous state is disabled. For categories 4 and 3, this integration must be two-channel (x/y paths). Single-channel integration in the control (z path) is only possible with a single-channel control and taking the risk analysis into account.

2) PELV in accordance with the requirements in EN 60204-1 / 6.4

Please see the operating instructions for the related devices to obtain information on the effects of the functions with configurable parameters. This information is to be observed.

Accessories required for commissioning

Description	Number	Items supplied	Further information
Alignment bracket for explosion-proof enclosure	2	-	→ Terminal and alignment brackets
Connecting cable	2	✓	→ Plug connectors and cables
Cable gland (depending on region)	2	-	→ Plug connectors and cables
Service cable for parameter setting	1	✓	→ Plug connectors and cables
CDS (Configuration & Diagnostic Software)	1	✓	-
Operating instructions	1	✓	-
Test rod	1	✓	→ Test and monitoring tools

Accessories

Mounting systems

Terminal and alignment brackets

Alignment brackets

Figure	Description	Packing unit	Model name	Part no.
	Alignment bracket for explosion-proof enclosure	2 pieces	BEF-1SHABRST2	2072525
	Mounting kit, consisting of: 2 x reinforced stainless steel bracket swivel mount, with riser, 1 x mounting bracket, L-shaped with riser	3 pieces	BEF-3AAAARST4	2074626

Device protection (mechanical)

Protective housings and protective pipes

Figure	Description	Packing unit	Model name	Part no.
	Explosion-proof enclosure for safety light curtains with protective field height of 600 mm	1 piece	EXA-06A0000A000	1068382
	Explosion-proof enclosure for safety light curtains with protective field height of 900 mm	1 piece	EXA-09A0000A000	1068383
	Explosion-proof enclosure for safety light curtains with protective field height of 1,200 mm	1 piece	EXA-12A0000A000	1068384

Connection systems

Plug connectors and cables

Connecting cables with female connector

- **Model:** PVC, unshielded

Figure	Connection type		Conductor cross-section	Cable length	Model name	Part no.
	Female connector, M26, 12-pin, straight	Cable	0.75 mm ²	2.5 m	DOL-0612G2M5075KM0	2022544
				5 m	DOL-0612G05M075KM0	2022545
				7.5 m	DOL-0612G7M5075KM0	2022546
				10 m	DOL-0612G10M075KM0	2022547
				15 m	DOL-0612G15M075KM0	2022548
				20 m	DOL-0612G20M075KM0	2022549
				30 m	DOL-0612G30M075KM0	2022550
				50 m	DOL-0612G50MD75KM0	2033548

Connection cables with male connector and male connector

- **Model:** PVC, unshielded

Figure	Connection type		Description	Cable length	Model name	Part no.
	Male connector, M8, 4-pin, straight	Male connector, USB-A, straight	For connecting the configuration connection to the USB interface on the PC	2 m	DSL-8U04G02M025KM1	6034574
				10 m	DSL-8U04G10M025KM1	6034575

Cables (ready to assemble)

- **Model:** PVC, unshielded

Figure	Description	Conductor cross-section	Number of cores	Items supplied	Model name	Part no.
	Max. 100 m, fitting for EFI connections	0.75 mm ²	12-pole	By the meter	Connecting cable	6021437

Cable gland

Description	Model name	Part no.
Cable gland for the European market	Cable gland	5329002

Modules and gateways

EFI gateways

Figure	Description	Model name	Part no.
	CANopen	UE1940-I220000	1040397
	Ethernet TCP/IP	UE1840-22H0000	1029100
	PROFIBUS DP	UE1140-22I0000	1029099



Figure	Description	Model name	Part no.
	PROFIBUS PROFI-safe	UE4140-22I0000	1029098
	PROFINET PROFI-safe	UE4740-22H0000	1046978

Power supply units and power cord connectors

Figure	Input voltage	Output voltage	Output current	Model name	Part no.
	100 V AC ... 240 V AC	24 V DC	≤ 2.1 A	Power supply	7028789
			≤ 3.9 A	Power supply	7028790



Reflectors and optics

Alignment aids

Figure	Description	Model name	Part no.
	Laser alignment aid for various sensors, laser class 2 (IEC 60825): Never look into the beam.	AR60	1015741
	Adapter AR60 for explosion-proof enclosure	Adapter AR60, Ex	2074849

Deflector mirrors

- **Mirror material:** glass

Figure	Description	Items supplied	Suitable for protective field height	Model name	Part no.
	Horizontal deflection	Incl. mounting kit swivel mount. Pay attention to the reduction of the scanning range!	150 mm ... 600 mm	PNS125-064	1019427
			150 mm ... 900 mm	PNS125-094	1019429
			150 mm ... 1,200 mm	PNS125-124	1019431
	Vertical deflection	Incl. mounting kit swivel mount. Pay attention to the reduction of the scanning range!	150 mm ... 600 mm	PNS75-064	1019416
			150 mm ... 900 mm	PNS75-094	1019418
			150 mm ... 1,200 mm	PNS75-124	1019420

Further accessories

Test and monitoring tools

Figure	Description	Model name	Part no.
	30 mm diameter	Test rod 30 mm	2022602
	Test rod holder	BEF-3WNAAAAL1	2052249

WWW.MYSICK.COM – SEARCH ONLINE AND ORDER

Search online quickly and safely – with the SICK “Finders”

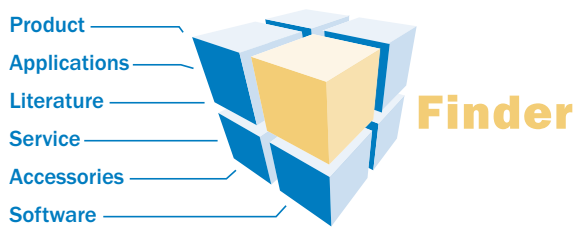

Product Finder: We can help you to quickly target the product that best matches your application.

Applications Finder: Select the application description on the basis of the challenge posed, industrial sector, or product group.

Literature Finder: Go directly to the operating instructions, technical information, and other literature on all aspects of products from SICK.

These and other “Finders” at → www.mysick.com

Efficiency – with the e-commerce tools from SICK

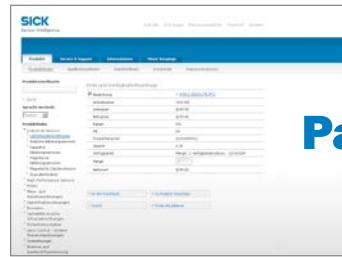

Partner Portal
www.mysick.com

Find out prices and availability: Determine the price and possible delivery date of your desired product simply and quickly at any time.

Request or view a quote: You can have a quote generated online here. Every quote is confirmed to you via e-mail.

Order online: You can go through the ordering process in just a few steps.

SERVICES FOR MACHINES AND SYSTEMS: SICK LifeTime Services

Our comprehensive and versatile LifeTime Services are the perfect addition to the comprehensive range of products from SICK. The services range from product-independent consulting to traditional product services.



Consulting & Design
Safe and professional



Product & System Support
Reliable, fast and on-site



Verification & Optimization
Safe and regularly inspected



Upgrade & Retrofits
Easy, safe, economical



Training & Education
Practical, focused and professional

SICK AT A GLANCE

SICK is a leading manufacturer of intelligent sensors and sensor solutions for industrial applications. With more than 6,500 employees and over 50 subsidiaries and equity investments as well as numerous representative offices worldwide, we are always close to our customers. A unique range of products and services creates the perfect basis for controlling processes securely and efficiently, protecting individuals from accidents and preventing damage to the environment.

We have extensive experience in various industries and understand their processes and requirements. With intelligent sensors, we can deliver exactly what our customers need. In application centers in Europe, Asia and North America, system solutions are tested and optimized in accordance with customer specifications. All this makes us a reliable supplier and development partner.

Comprehensive services round out our offering: SICK LifeTime Services provide support throughout the machine life cycle and ensure safety and productivity.

For us, that is “Sensor Intelligence.”

Worldwide presence:

Australia, Austria, Belgium/Luxembourg, Brazil, Czech Republic, Canada, China, Denmark, Finland, France, Germany, Great Britain, Hungary, India, Israel, Italy, Japan, Mexico, Netherlands, Norway, Poland, Romania, Russia, Singapore, Slovenia, South Africa, South Korea, Spain, Sweden, Switzerland, Taiwan, Turkey, United Arab Emirates, USA

Detailed addresses and additional representatives → www.sick.com